



# PMBT2907AQA

60V, 600 mA PNP switching transistor

21 September 2018

Product data sheet

## 1. General description

PNP switching transistor in an ultra small DFN1010D-3 (SOT1215) leadless Surface-Mounted Device (SMD) plastic package with visible and solderable side pads.

NPN complement: PMBT2222AQA

## 2. Features and benefits

- High current (max. 600 mA)
- Low voltage (max. 60V)
- Leadless ultra small SMD plastic package
- Low package height of 0.37 mm
- Suitable for Automatic Optical Inspection (AOI) of solder joint
- AEC-Q101 qualified

## 3. Applications

- Switching and linear applications
- Mobile applications

## 4. Quick reference data

Table 1. Quick reference data

Symbol	Parameter	Conditions	Min	Typ	Max	Unit
$V_{CEO}$	collector-emitter voltage	open base	-	-	-60	V
$I_C$	collector current		-	-	-600	mA
$I_{CM}$	peak collector current	single pulse; $t_p \leq 1$ ms	-	-	-800	mA
$h_{FE}$	DC current gain	$V_{CE} = -10$ V; $I_C = -150$ mA	[1]	100	-	300
		$V_{CE} = -10$ V; $I_C = -500$ mA	[1]	50	-	-

[1] Pulsed test:  $t_p \leq 300$   $\mu$ s;  $\delta \leq 0.02$

### 5. Pinning information

Table 2. Pinning information

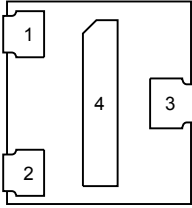
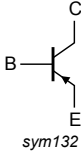
Pin	Symbol	Description	Simplified outline	Graphic symbol
1	B	base	 <p>Transparent top view DFN1010D-3 (SOT1215)</p>	 <p>sym132</p>
2	E	emitter		
3	C	collector		
4	C	collector		

### 6. Ordering information

Table 3. Ordering information

Type number	Package		
	Name	Description	Version
PMBT2907AQA	DFN1010D-3	plastic, leadless thermal enhanced ultra thin small outline package; 3 terminals; 0.75 mm pitch; 1.1 mm x 1 mm x 0.37 mm body	SOT1215

### 7. Marking

Table 4. Marking codes

Type number	Marking code
PMBT2907AQA	X 101

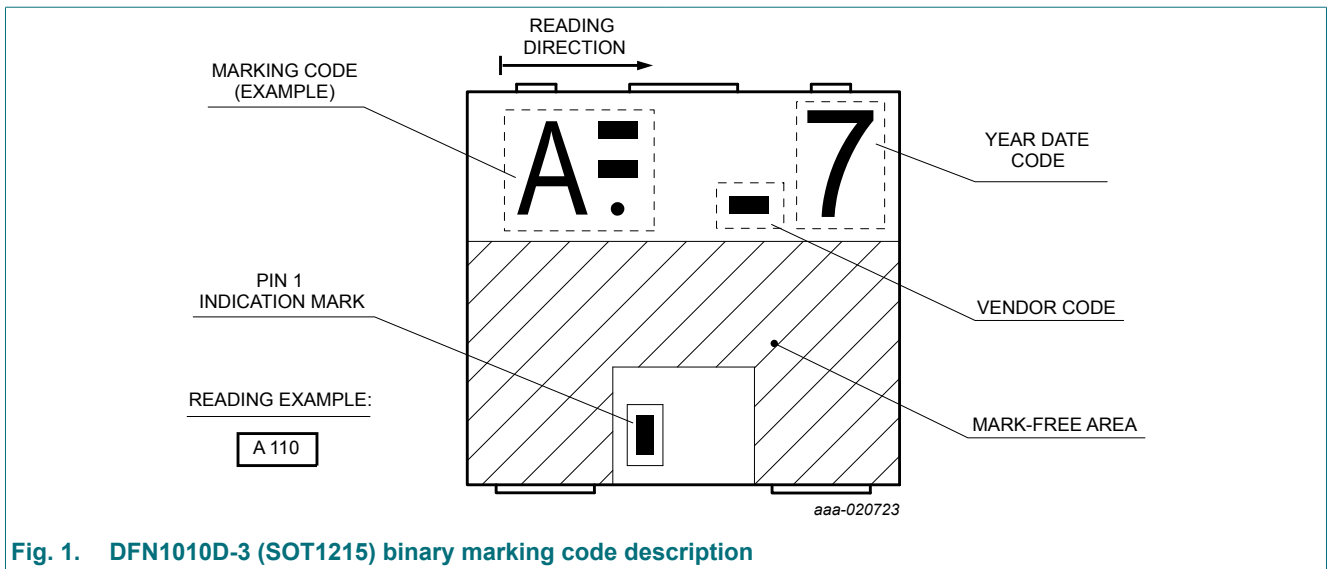

## 8. Limiting values

**Table 5. Limiting values**

In accordance with the Absolute Maximum Rating System (IEC 60134).

Symbol	Parameter	Conditions	Min	Max	Unit	
$V_{CBO}$	collector-base voltage	open emitter	-	-60	V	
$V_{CEO}$	collector-emitter voltage	open base	-	-60	V	
$V_{EBO}$	emitter-base voltage	open collector	-	-5	V	
$I_C$	collector current		-	-600	mA	
$I_{CM}$	peak collector current	single pulse; $t_p \leq 1$ ms	-	-800	mA	
$I_{BM}$	peak base current		-	-200	mA	
$P_{tot}$	total power dissipation	$T_{amb} \leq 25$ °C	[1]	-	325	mW
			[2]	-	575	mW
			[3]	-	525	mW
			[4]	-	940	mW
$T_j$	junction temperature		-	150	°C	
$T_{amb}$	ambient temperature		-55	150	°C	
$T_{stg}$	storage temperature		-65	150	°C	

- [1] Device mounted on an FR4 Printed-Circuit Board (PCB), single-sided copper, tin-plated and standard footprint.
- [2] Device mounted on an FR4 Printed-Circuit Board (PCB), single-sided copper, tin-plated; mounting pad for collector 1 cm<sup>2</sup>.
- [3] Device mounted on an FR4 Printed-Circuit Board (PCB), 4-layer copper, tin-plated and standard footprint.
- [4] Device mounted on an FR4 Printed-Circuit Board (PCB), 4-layer copper, tin-plated; mounting pad for collector 1 cm<sup>2</sup>.

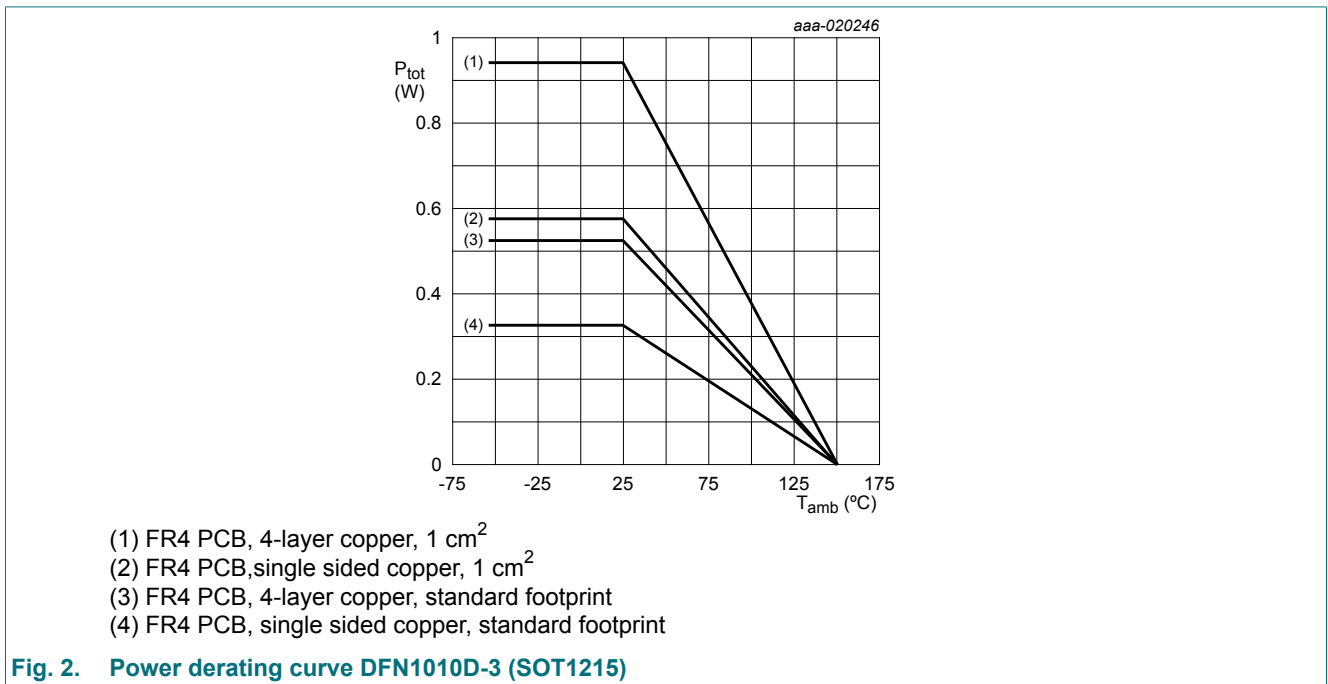

### 9. Thermal characteristics

Table 6. Thermal characteristics

Symbol	Parameter	Conditions	Min	Typ	Max	Unit	
$R_{th(j-a)}$	thermal resistance from junction to ambient	in free air	[1]	-	-	385	K/W
			[2]	-	-	218	K/W
			[3]	-	-	239	K/W
			[4]	-	-	133	K/W

- [1] Device mounted on an FR4 PCB, single-sided copper, tin-plated and standard footprint.
- [2] Device mounted on an FR4 Printed-Circuit Board (PCB), single-sided copper, tin-plated; mounting pad for collector 1 cm<sup>2</sup>.
- [3] Device mounted on an FR4 PCB, 4-layer copper, tin-plated and standard footprint.
- [4] Device mounted on an FR4 Printed-Circuit Board (PCB), 4-layer copper, tin-plated; mounting pad for collector 1 cm<sup>2</sup>.

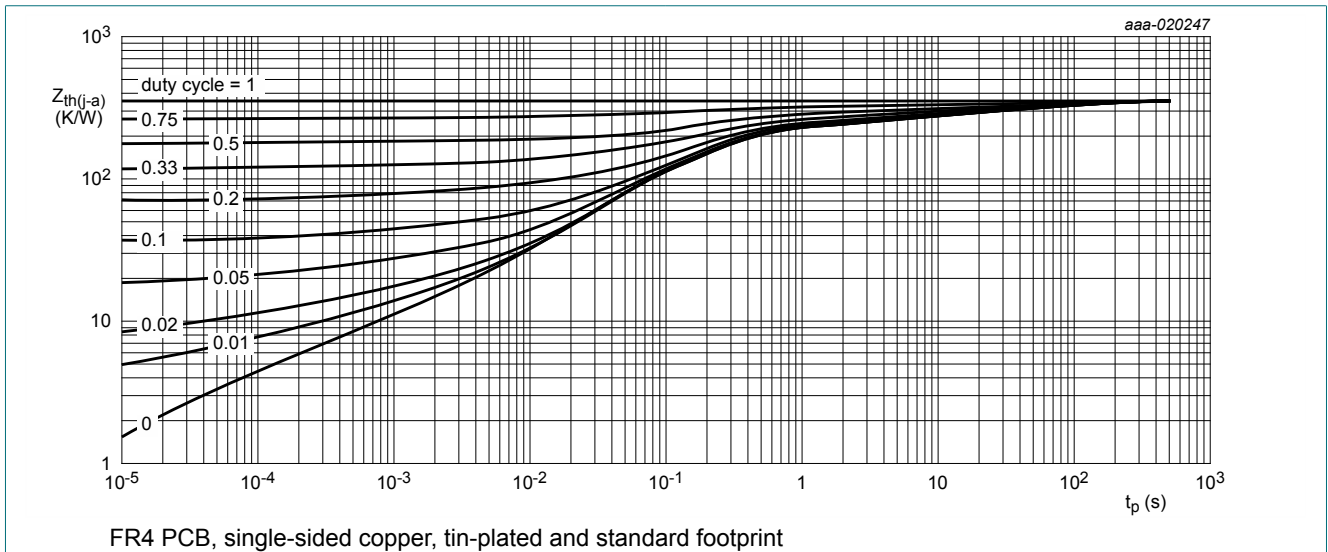

Fig. 3. Transient thermal impedance from junction to ambient as a function of pulse duration; typical values

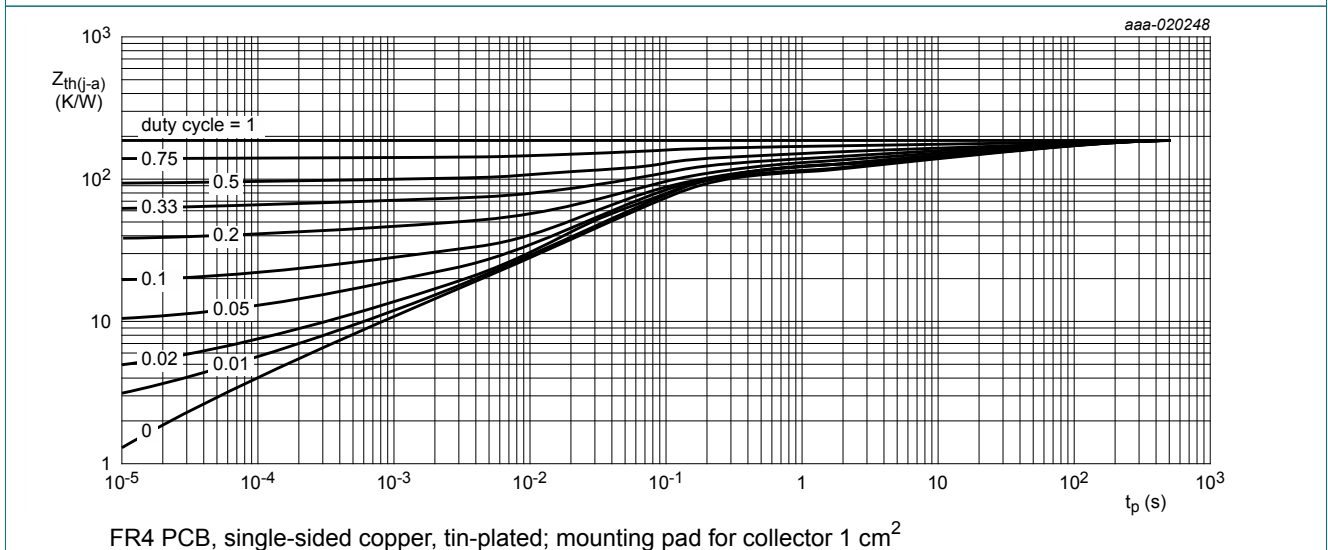
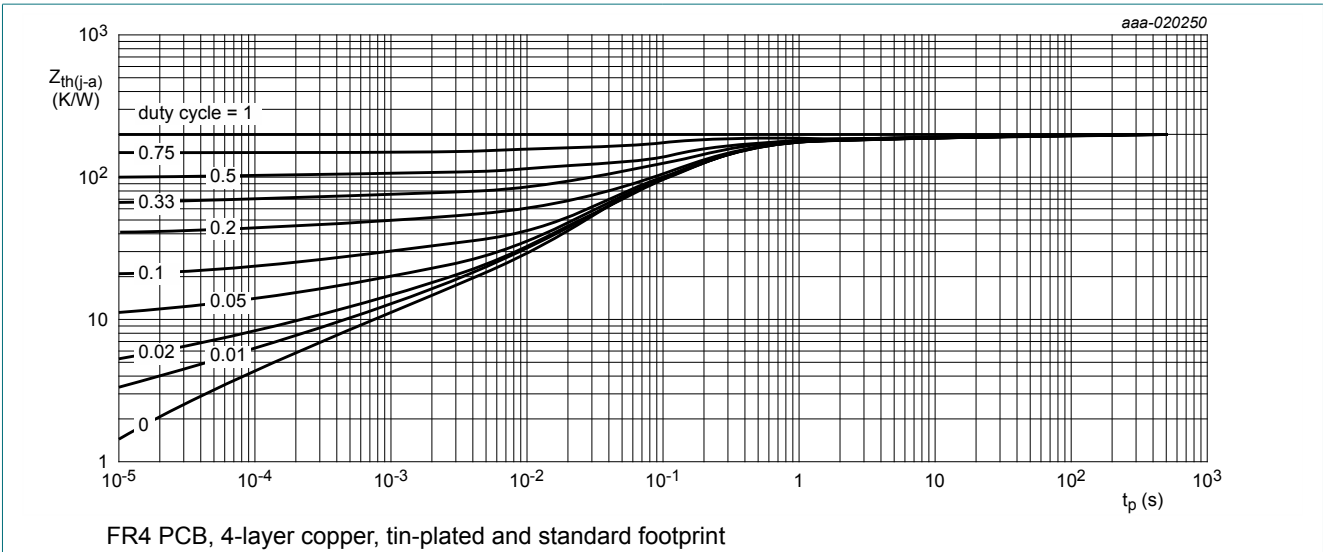
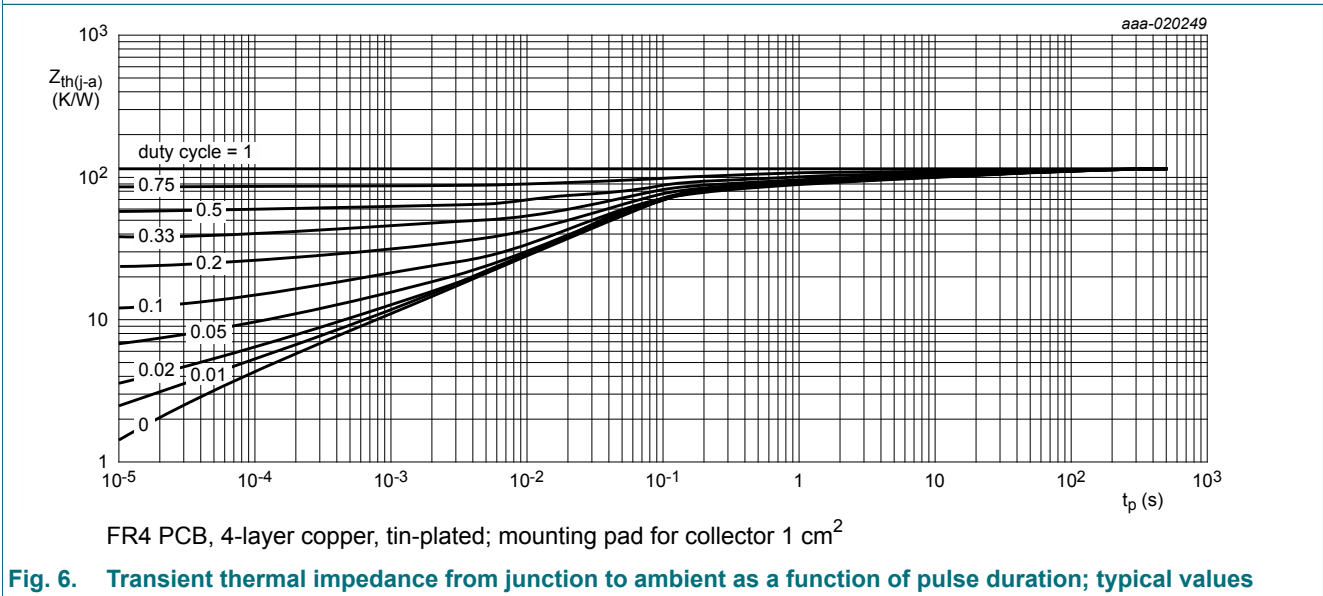

Fig. 4. Transient thermal impedance from junction to ambient as a function of pulse duration; typical values



**Fig. 5. Transient thermal impedance from junction to ambient as a function of pulse duration; typical values**



**Fig. 6. Transient thermal impedance from junction to ambient as a function of pulse duration; typical values**

## 10. Characteristics

**Table 7. Characteristics**
 $T_{amb} = 25\text{ °C}$  unless otherwise specified

Symbol	Parameter	Conditions	Min	Typ	Max	Unit	
$V_{(BR)CBO}$	collector-base breakdown voltage	$I_C = -100\ \mu\text{A}$ ; $I_E = 0\ \text{A}$	-60	-	-	V	
$V_{(BR)CEO}$	collector-emitter breakdown voltage	$I_C = -2\ \text{mA}$ ; $I_B = 0\ \text{A}$	-60	-	-	V	
$V_{(BR)EBO}$	emitter-base breakdown voltage	$I_C = 0\ \text{A}$ ; $I_E = -100\ \mu\text{A}$	-5	-	-	V	
$I_{CBO}$	collector-base cut-off current	$V_{CB} = -50\ \text{V}$ ; $I_E = 0\ \text{A}$	-	-	-10	nA	
		$V_{CB} = -50\ \text{V}$ ; $I_E = 0\ \text{A}$ ; $T_j = 125\text{ °C}$	-	-	-10	$\mu\text{A}$	
$I_{EBO}$	emitter-base cut-off current	$V_{EB} = -5\ \text{V}$ ; $I_C = 0\ \text{A}$	-	-	-50	nA	
$h_{FE}$	DC current gain	$V_{CE} = -10\ \text{V}$ ; $I_C = -100\ \mu\text{A}$	75	-	-		
		$V_{CE} = -10\ \text{V}$ ; $I_C = -1\ \text{mA}$	100	-	-		
		$V_{CE} = -10\ \text{V}$ ; $I_C = -10\ \text{mA}$	100	-	-		
		$V_{CE} = -10\ \text{V}$ ; $I_C = -150\ \text{mA}$	[1]	100	-	300	
		$V_{CE} = -10\ \text{V}$ ; $I_C = -500\ \text{mA}$	[1]	50	-	-	
$V_{CEsat}$	collector-emitter saturation voltage	$I_C = -150\ \text{mA}$ ; $I_B = -15\ \text{mA}$	[1]	-	-400	mV	
		$I_C = -500\ \text{mA}$ ; $I_B = -50\ \text{mA}$	[1]	-	-1.6	V	
$V_{BEsat}$	base-emitter saturation voltage	$I_C = -150\ \text{mA}$ ; $I_B = -15\ \text{mA}$	[1]	-	-1.3	V	
		$I_C = -500\ \text{mA}$ ; $I_B = -50\ \text{mA}$	[1]	-	-2.6	V	
$t_d$	delay time	$I_C = -150\ \text{mA}$ ; $I_{B(on)} = -15\ \text{mA}$ ; $I_{B(off)} = 15\ \text{mA}$	-	-	15	ns	
$t_r$	rise time		-	-	30	ns	
$t_{on}$	turn-on time		-	-	45	ns	
$t_s$	storage time		-	-	300	ns	
$t_f$	fall time		-	-	65	ns	
$t_{off}$	turn-off time		-	-	365	ns	
$C_c$	collector capacitance		$V_{CB} = -10\ \text{V}$ ; $I_E = 0\ \text{A}$ ; $i_e = 0\ \text{A}$ ; $f = 1\ \text{MHz}$	-	-	8	pF
$C_e$	emitter capacitance	$V_{EB} = -2\ \text{V}$ ; $I_C = 0\ \text{A}$ ; $i_c = 0\ \text{A}$ ; $f = 1\ \text{MHz}$	-	-	30	pF	
$f_T$	transition frequency	$V_{CE} = -20\ \text{V}$ ; $I_C = -50\ \text{mA}$ ; $f = 100\ \text{MHz}$	[1]	210	-	MHz	

[1] Pulsed test:  $t_p \leq 300\ \mu\text{s}$ ;  $\delta \leq 0.02$

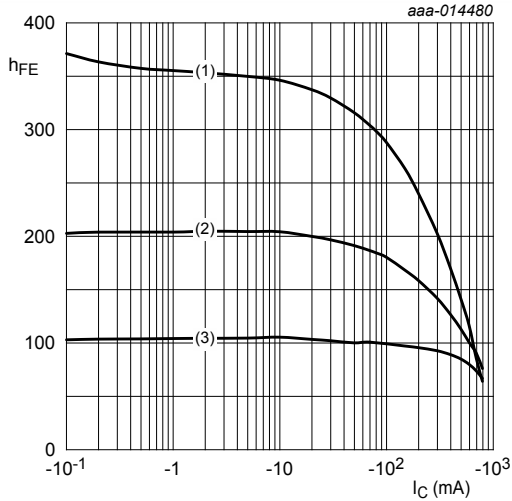

$V_{CE} = -10\text{ V}$   
 (1)  $T_{amb} = 150^\circ\text{C}$   
 (2)  $T_{amb} = 25^\circ\text{C}$   
 (3)  $T_{amb} = -55^\circ\text{C}$

Fig. 7. DC current gain as a function of collector current; typical values

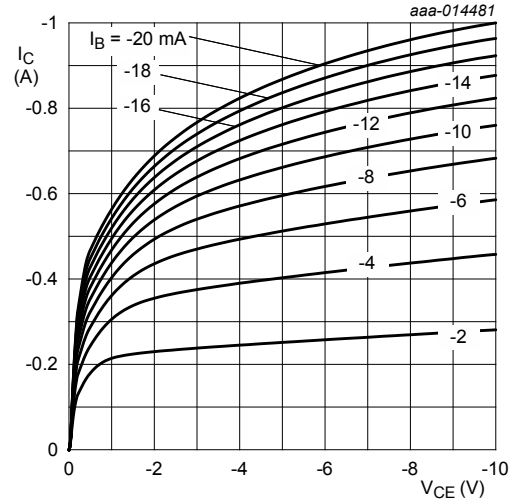

$T_{amb} = 25^\circ\text{C}$

Fig. 8. Collector current as a function of collector-emitter voltage; typical values

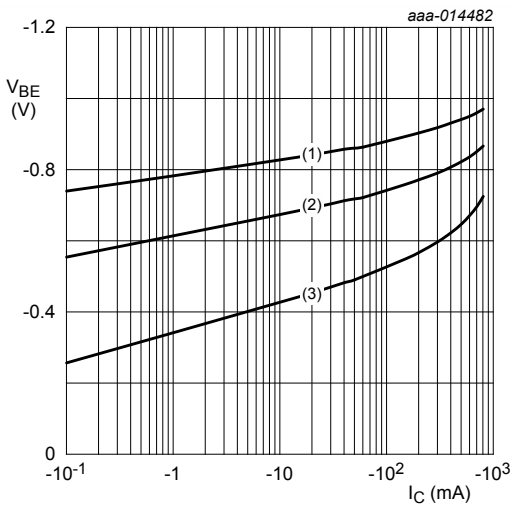

$V_{CE} = -10\text{ V}$   
 (1)  $T_{amb} = -55^\circ\text{C}$   
 (2)  $T_{amb} = 25^\circ\text{C}$   
 (3)  $T_{amb} = 150^\circ\text{C}$

Fig. 9. Base-emitter voltage as a function of collector current; typical values

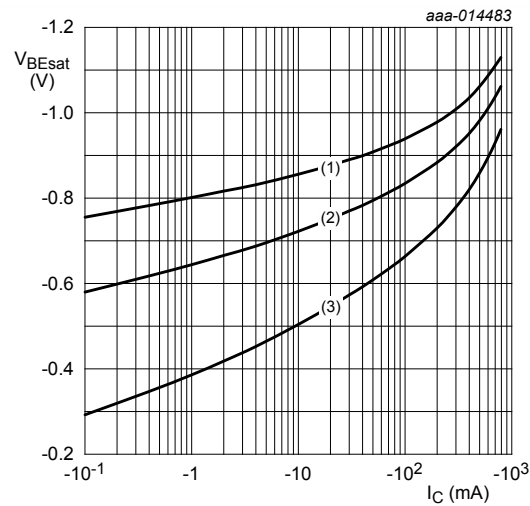

$I_C/I_B = 10$   
 (1)  $T_{amb} = -55^\circ\text{C}$   
 (2)  $T_{amb} = 25^\circ\text{C}$   
 (3)  $T_{amb} = 150^\circ\text{C}$

Fig. 10. Base-emitter saturation voltage as a function of collector current; typical values

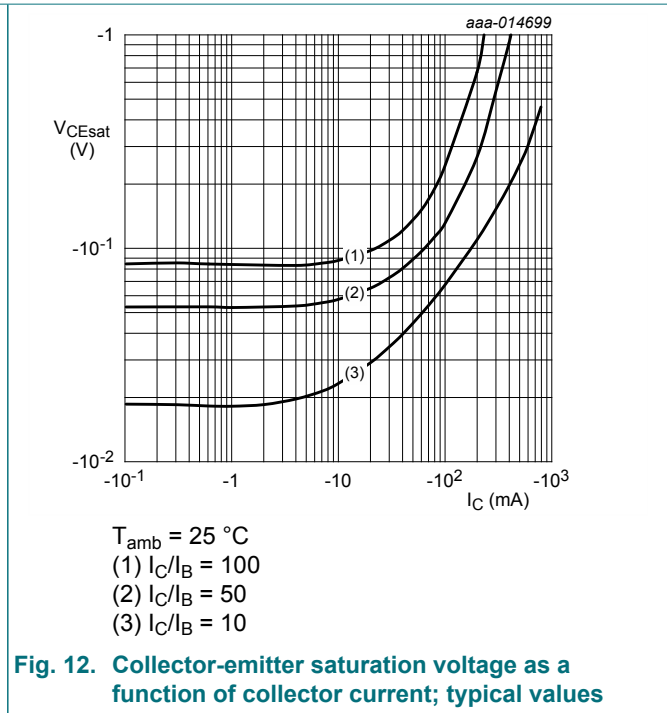
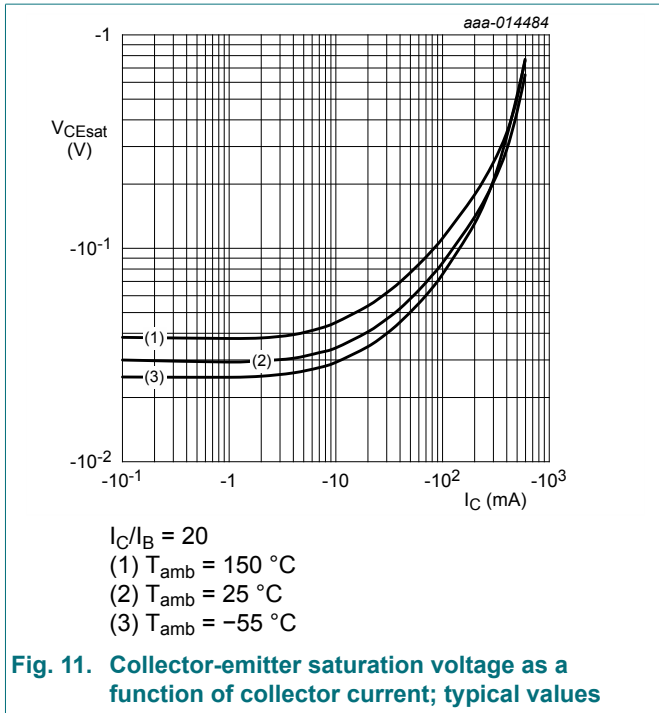

## 11. Test information

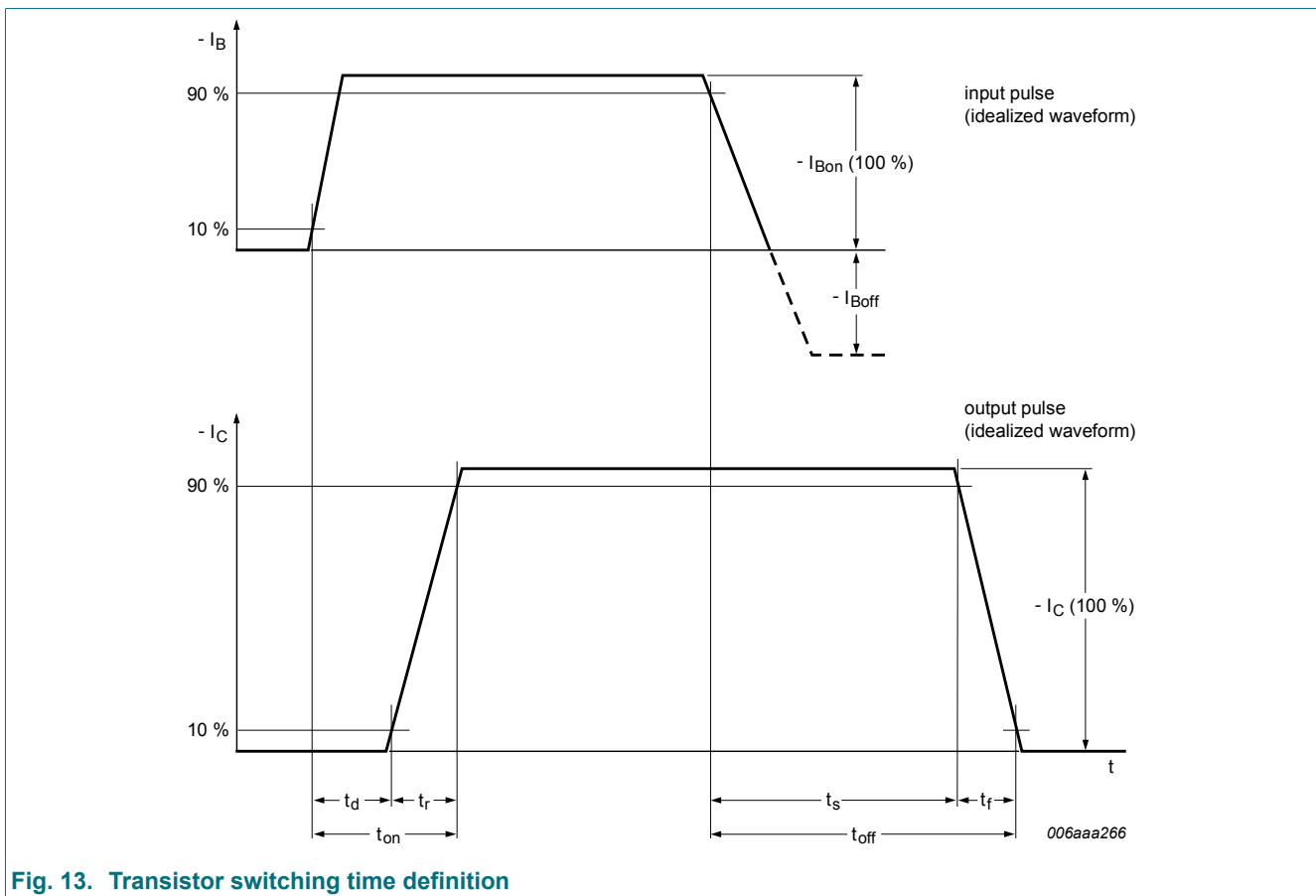



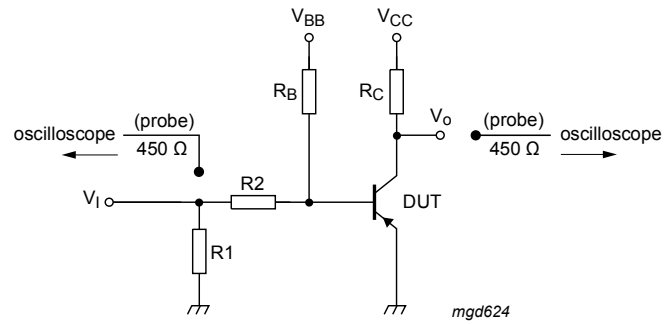

Fig. 14. Test circuit for switching times

### Quality information

This product has been qualified in accordance with the Automotive Electronics Council (AEC) standard *Q101 - Stress test qualification for discrete semiconductors*, and is suitable for use in automotive applications.

## 12. Package outline

DFN1010D-3: plastic thermal enhanced ultra thin small outline package; no leads;  
3 terminals; body: 1.1 x 1.0 x 0.37 mm

SOT1215

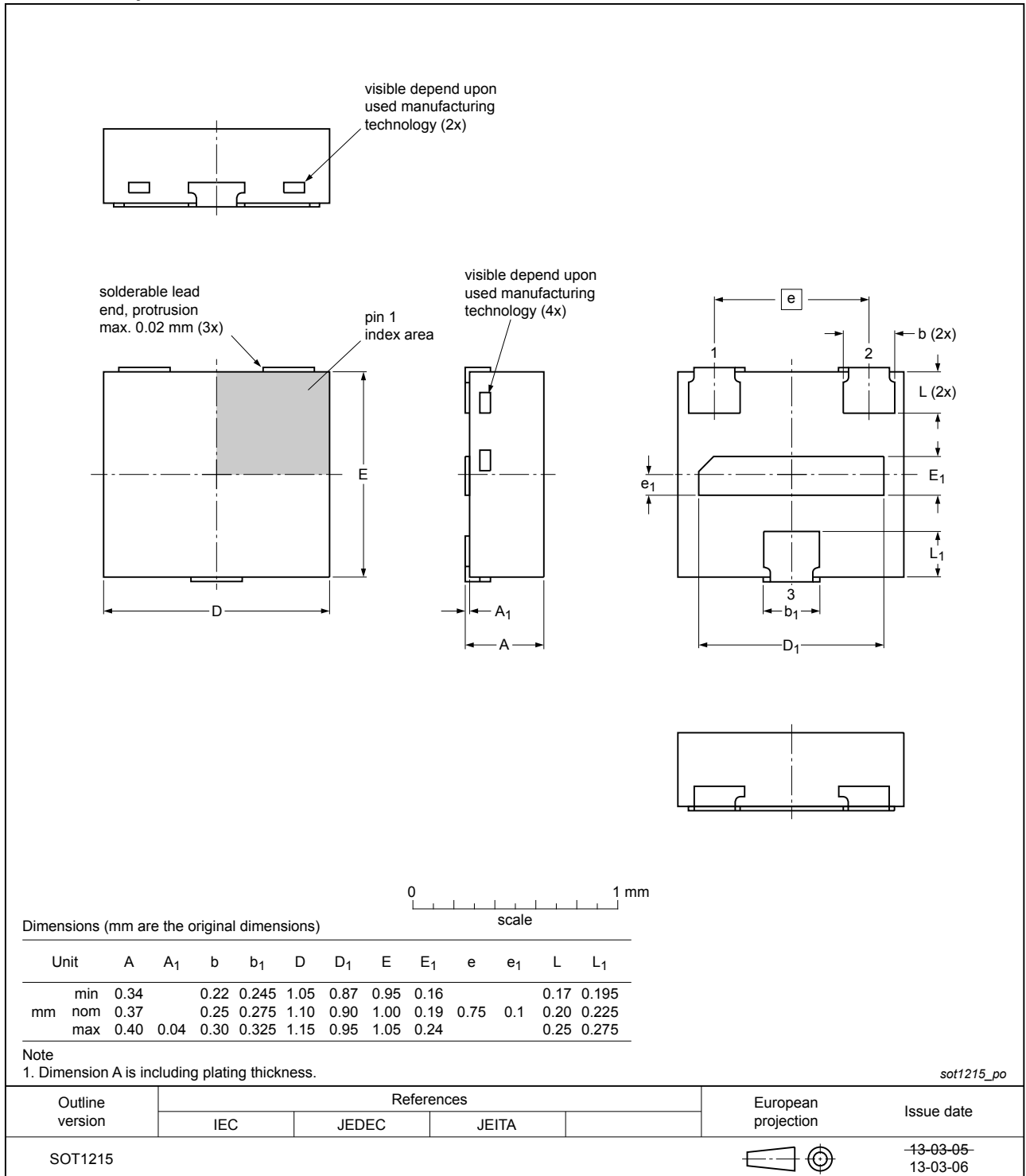

Fig. 15. Package outline DFN1010D-3 (SOT1215)

### 13. Soldering

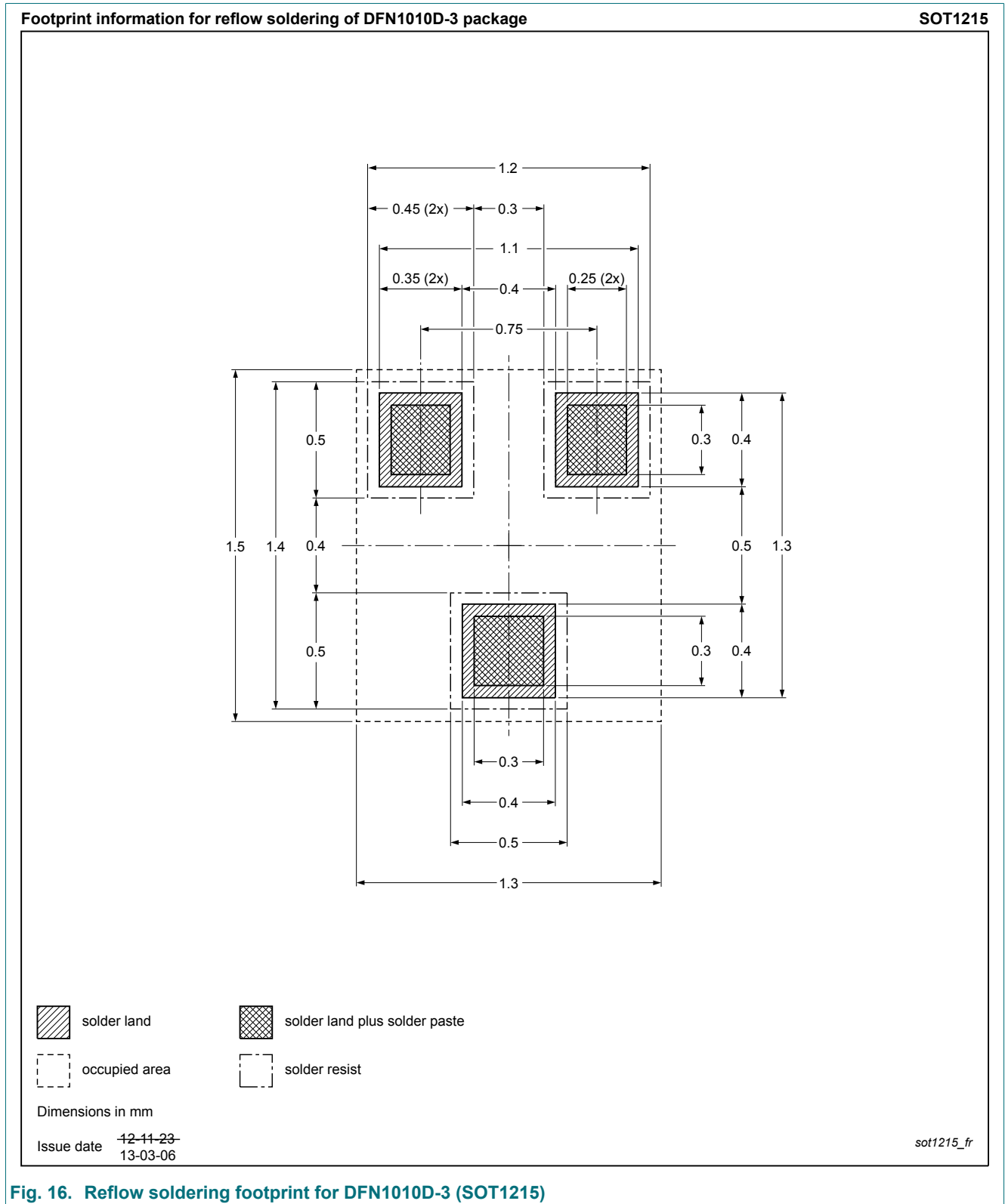

Fig. 16. Reflow soldering footprint for DFN1010D-3 (SOT1215)

## 14. Revision history

Table 8. Revision history

Data sheet ID	Release date	Data sheet status	Change notice	Supersedes
PMBT2907AQA v.1	20180921	Product data sheet	-	-

## 15. Legal information

### Data sheet status

Document status [1][2]	Product status [3]	Definition
Objective [short] data sheet	Development	This document contains data from the objective specification for product development.
Preliminary [short] data sheet	Qualification	This document contains data from the preliminary specification.
Product [short] data sheet	Production	This document contains the product specification.

- [1] Please consult the most recently issued document before initiating or completing a design.
- [2] The term 'short data sheet' is explained in section "Definitions".
- [3] The product status of device(s) described in this document may have changed since this document was published and may differ in case of multiple devices. The latest product status information is available on the internet at <https://www.nexperia.com>.

### Definitions

**Draft** — The document is a draft version only. The content is still under internal review and subject to formal approval, which may result in modifications or additions. Nexperia does not give any representations or warranties as to the accuracy or completeness of information included herein and shall have no liability for the consequences of use of such information.

**Short data sheet** — A short data sheet is an extract from a full data sheet with the same product type number(s) and title. A short data sheet is intended for quick reference only and should not be relied upon to contain detailed and full information. For detailed and full information see the relevant full data sheet, which is available on request via the local Nexperia sales office. In case of any inconsistency or conflict with the short data sheet, the full data sheet shall prevail.

**Product specification** — The information and data provided in a Product data sheet shall define the specification of the product as agreed between Nexperia and its customer, unless Nexperia and customer have explicitly agreed otherwise in writing. In no event however, shall an agreement be valid in which the Nexperia product is deemed to offer functions and qualities beyond those described in the Product data sheet.

### Disclaimers

**Limited warranty and liability** — Information in this document is believed to be accurate and reliable. However, Nexperia does not give any representations or warranties, expressed or implied, as to the accuracy or completeness of such information and shall have no liability for the consequences of use of such information. Nexperia takes no responsibility for the content in this document if provided by an information source outside of Nexperia.

In no event shall Nexperia be liable for any indirect, incidental, punitive, special or consequential damages (including - without limitation - lost profits, lost savings, business interruption, costs related to the removal or replacement of any products or rework charges) whether or not such damages are based on tort (including negligence), warranty, breach of contract or any other legal theory.

Notwithstanding any damages that customer might incur for any reason whatsoever, Nexperia's aggregate and cumulative liability towards customer for the products described herein shall be limited in accordance with the Terms and conditions of commercial sale of Nexperia.

**Right to make changes** — Nexperia reserves the right to make changes to information published in this document, including without limitation specifications and product descriptions, at any time and without notice. This document supersedes and replaces all information supplied prior to the publication hereof.

**Suitability for use in automotive applications** — This Nexperia product has been qualified for use in automotive applications. Unless otherwise agreed in writing, the product is not designed, authorized or warranted to be suitable for use in life support, life-critical or safety-critical systems or

equipment, nor in applications where failure or malfunction of an Nexperia product can reasonably be expected to result in personal injury, death or severe property or environmental damage. Nexperia and its suppliers accept no liability for inclusion and/or use of Nexperia products in such equipment or applications and therefore such inclusion and/or use is at the customer's own risk.

**Quick reference data** — The Quick reference data is an extract of the product data given in the Limiting values and Characteristics sections of this document, and as such is not complete, exhaustive or legally binding.

**Applications** — Applications that are described herein for any of these products are for illustrative purposes only. Nexperia makes no representation or warranty that such applications will be suitable for the specified use without further testing or modification.

Customers are responsible for the design and operation of their applications and products using Nexperia products, and Nexperia accepts no liability for any assistance with applications or customer product design. It is customer's sole responsibility to determine whether the Nexperia product is suitable and fit for the customer's applications and products planned, as well as for the planned application and use of customer's third party customer(s). Customers should provide appropriate design and operating safeguards to minimize the risks associated with their applications and products.

Nexperia does not accept any liability related to any default, damage, costs or problem which is based on any weakness or default in the customer's applications or products, or the application or use by customer's third party customer(s). Customer is responsible for doing all necessary testing for the customer's applications and products using Nexperia products in order to avoid a default of the applications and the products or of the application or use by customer's third party customer(s). Nexperia does not accept any liability in this respect.

**Limiting values** — Stress above one or more limiting values (as defined in the Absolute Maximum Ratings System of IEC 60134) will cause permanent damage to the device. Limiting values are stress ratings only and (proper) operation of the device at these or any other conditions above those given in the Recommended operating conditions section (if present) or the Characteristics sections of this document is not warranted. Constant or repeated exposure to limiting values will permanently and irreversibly affect the quality and reliability of the device.

**Terms and conditions of commercial sale** — Nexperia products are sold subject to the general terms and conditions of commercial sale, as published at <http://www.nexperia.com/profile/terms>, unless otherwise agreed in a valid written individual agreement. In case an individual agreement is concluded only the terms and conditions of the respective agreement shall apply. Nexperia hereby expressly objects to applying the customer's general terms and conditions with regard to the purchase of Nexperia products by customer.

**No offer to sell or license** — Nothing in this document may be interpreted or construed as an offer to sell products that is open for acceptance or the grant, conveyance or implication of any license under any copyrights, patents or other industrial or intellectual property rights.

**Export control** — This document as well as the item(s) described herein may be subject to export control regulations. Export might require a prior authorization from competent authorities.

**Translations** — A non-English (translated) version of a document is for reference only. The English version shall prevail in case of any discrepancy between the translated and English versions.

### Trademarks

Notice: All referenced brands, product names, service names and trademarks are the property of their respective owners.

## Contents

---

1. General description.....	1
2. Features and benefits.....	1
3. Applications.....	1
4. Quick reference data.....	1
5. Pinning information.....	2
6. Ordering information.....	2
7. Marking.....	2
8. Limiting values.....	3
9. Thermal characteristics.....	4
10. Characteristics.....	6
11. Test information.....	8
12. Package outline.....	10
13. Soldering.....	11
14. Revision history.....	12
15. Legal information.....	13

---

© Nexperia B.V. 2018. All rights reserved

For more information, please visit: <http://www.nexperia.com>  
For sales office addresses, please send an email to: [salesaddresses@nexperia.com](mailto:salesaddresses@nexperia.com)  
Date of release: 21 September 2018

---

# Mouser Electronics

Authorized Distributor

Click to View Pricing, Inventory, Delivery & Lifecycle Information:

[Nexperia:](#)

[PMBT2907AQAZ](#)